

Diameter:

300 mm

R09_-3030H_-4T-2545



Fan with guard grill

Airflow Direction	Type	Code	Weight (kg)
Sucking	R09R-3030HA-4T-2545	0309-4-1038	3.0
Blowing	R09R-3030HP-4T-2545	On request	

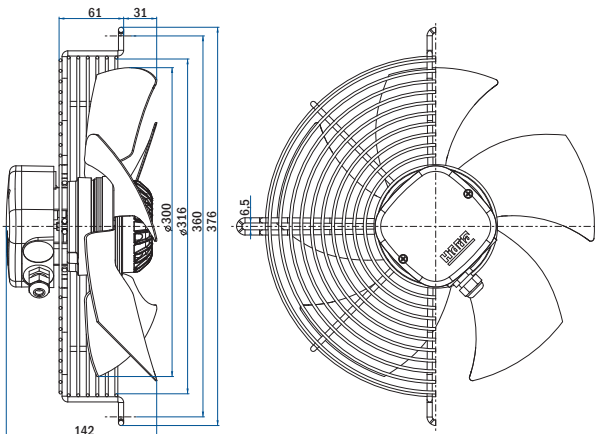

Fan with plate

Airflow Direction	Type	Code	Weight (kg)
Sucking	R09P-3030HA-4T-2545	On request	
Blowing	R09P-3030HP-4T-2545	On request	

Fan without guard grill

Airflow Direction	Type	Code	Weight (kg)
Sucking	R09E-3030HA-4T-2545	On request	
Blowing	R09E-3030HP-4T-2545	On request	

Nominal data according to standard EN 60335:	
Phase	3~
Nominal voltage	400/230 V
Frequency	50/60 Hz
Rated power input	75/80 W
Rated current	0.20/0.35/0.17/0.30 A
Rated speed	1370/1550 RPM
Min. ambient temperature	-30 °C
Max. ambient temperature	55 °C
Sound power level A weighted	67/72 dB (A)
Connection	terminal box
Insulation class	155
Protection class	IP54

ErP data according to EU regulation 327/2011:

Is not subject to the EU regulation 327/2011.

Power input lower than 125 W.

Aerodynamic characteristic

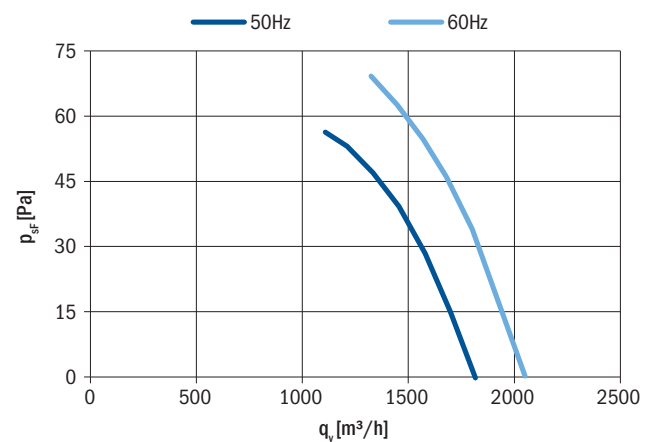

Fan characteristic measured in full bell mouth with guard grill

General notes

Connection diagram: Sucking	0301-1-0049	Page 146
Blowing	0301-1-0049	
Accessories		Page 134
Compliant to standards		Page 28